

Conveyor beam (输送梁)

FlexMod®

Beam(输送梁)

CXUCB 3

Length 3 mt
(长度3m)

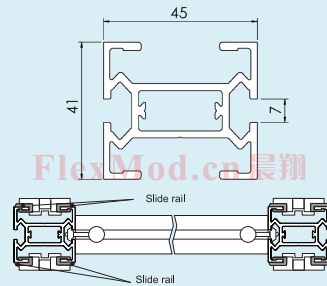

Slide rail (耐磨条)

Length 25 mt
(长度25m)

CXTCR 25H

Polyethylene
HDPE+PA6 Gray

CXTCR 25H

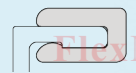

CXLAH 3X6A



CXLAH 3X6A

Aluminium rivet
(铝铆钉)

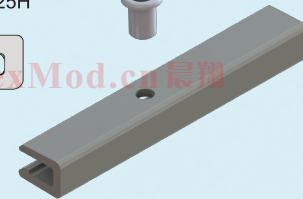

Connecting strip with set screws
(梁体连接条)

CXUCJ 5X100

Length 100

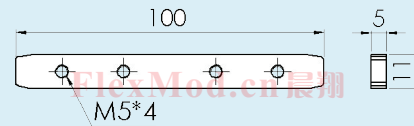

Half beam (半梁)

CXUCB 3H

Length 3 m

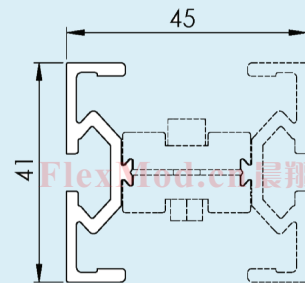

Beam clip (梁夹)

CXUCE 25X14

Including M6 screw and locking nut.

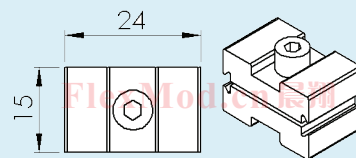

CX45-4

Conveyor beam (输送梁)

FlexMod®

Connecting strip kit (连接条)

CXUCJ 50

Connecting strip kit
Aluminium

Including M8 screws.

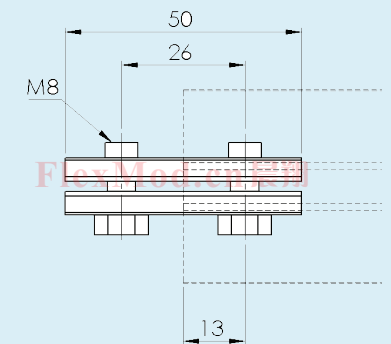
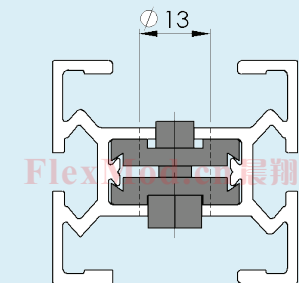
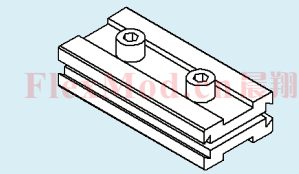

Drill instruction

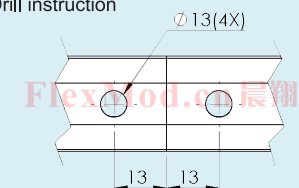

CX45

www.flexmod.cn

CX45-5