



卡通箱输送案例

Contents (目录)		Examples of application (应用场合)	14
Chains (链条)	2		
Conveyor beam (输送梁)	4		
End drive units (驱动单元)	6		
Idler end units (从动单元)	8		
Horizontal plain bends (水平弯头)	9		
Vertical bends (垂直弯头)	11		



Chain width 295 mm (链宽295mm)



**Technical characteristics (技术指标)**

Chain tension limit (链条张力极限)	.....1250 N
Beam width (型材宽度)	.....300 mm
Chain width (链条宽度)	.....295 mm
Chain pitch (链条节距)	.....33.5 mm
Item width (输送物品宽度)	.....70-500 mm
Maximum item weight (输送物品重量)	
Horizontal transport (水平传送)	.....15 kg
Maximum weight on conveyor (线体最大承载)	.....200 kg
Maximum conveyor length (线体最大长度)	.....30 m

CXB-295

**Examples of application**

Large cardboard boxes, products in soft plastic bags. Examples: detergent powder, wrapped tissue paper rolls, food products, personal care products.

**应用场合**

卡通箱、塑胶袋、包装纸、食品包装、个人用品、化工桶、塑胶瓶

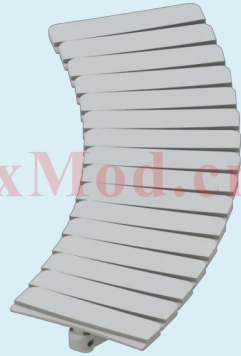

FlexMod.cn 晨翔

Plastic chain materials(链板材质)	Performance(特性)	Colour(颜色)
POM	Standard material/标准材料	white/白色
POML	Ultra low wear/超润滑	white/白色
POMA	Abrasion resistance/超耐磨	white/白色
POMC	Chemical resistance/抗腐蚀	yellow/黄色
POME	Conductive material/抗静电	black/黑色
POMK	High temperature resistance/耐高温	yellow/黄色
POMF	Food application/用于食品	white/白色
POMN	Low noise/低噪音	white/白色

*Plain chain (平板链)*

CXBTP 3A295 Plain chain (平板链)  
Length 5 mt (长度5m)

CXBTL 295 Plain link (平板链节)

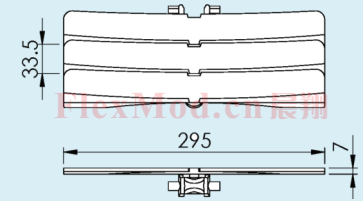
*Friction top chain (防滑顶链)*

CXBTP 3A295 F Plain chain (平板链)  
Length 5 mt (长度5m)

CXBTL 295 F Plain link (平板链节)

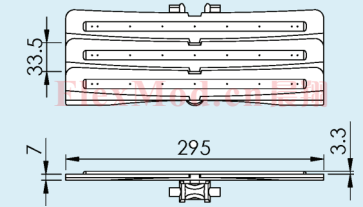
*Plain chain (平板链)*

CXBTP 3A295 A Plain chain (平板链)  
Length 5 mt (长度5m)

CXBTL 295 A Plain link (平板链节)

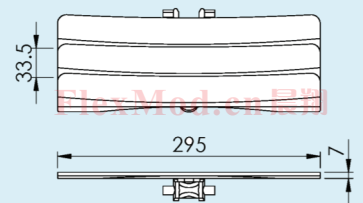
*Friction top chain (防滑顶链)*

CXBTP 3A295 AF Plain chain (平板链)  
Length 5 mt (长度5m)

CXBTL 295 AF Plain link (平板链节)

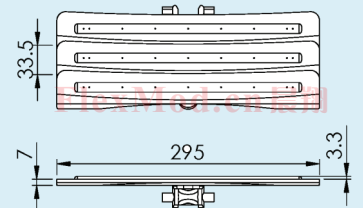
*Tools and accessories (工具和附件)*

CXBTT 13X16 Plastic pivot (塑料珠)  
CXMTT 13X16 Plastic pivot (塑料珠)  
CXMTD 6X50 Steel pin (钢销)  
CXB MJ 6P Pin insertion tool (销子安装工具)  
CXB MJ 6 Pin insertion tool (销子安装工具)

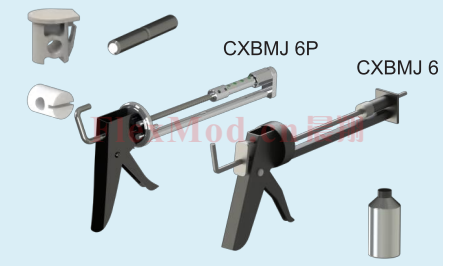

## Conveyor beam (输送梁)

FlexMod®

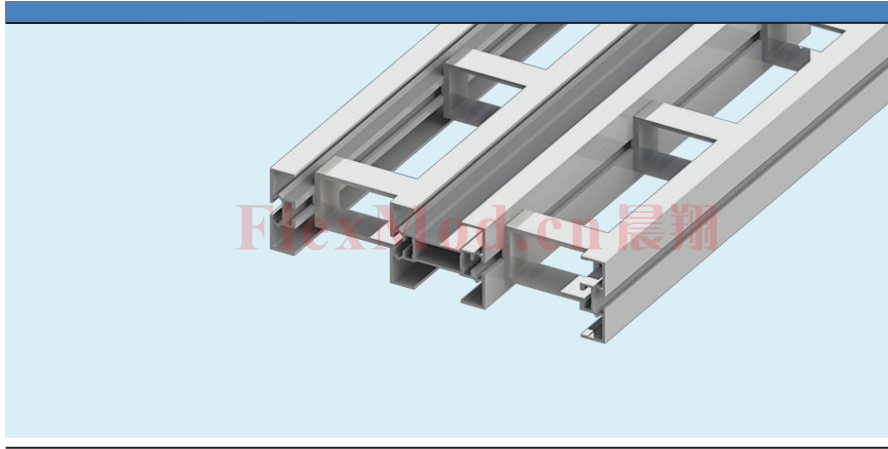

CXB-295-4

## Conveyor beam (输送梁)

FlexMod®

Beam (输送梁)

CXBCB 3A295 Length 3 mt (长度3m)

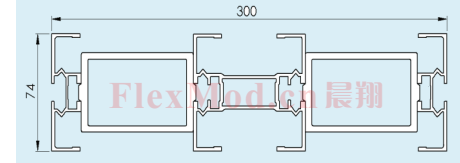

CXBCB 3A85 Length 3 mt (长度3m)

CXBCB 3A H Length 3 mt (长度3m)

CXBCE 85 Snap-fit clip kit for outer beam

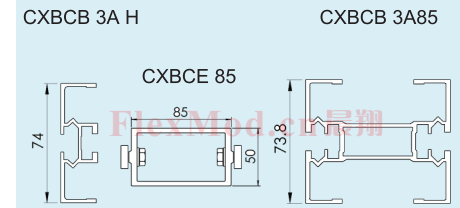

Slide rail (耐磨条) Length 25 m (长度25m)  
 CXBCR 3 HDPE Gray-black  
 CXBCR 25 HDPE Black/White(聚乙烯)  
 CXBCR 25P PVDF White(聚偏氟乙烯)

CXLAH 4X8A Aluminium rivet (铝铆钉)  
 CXLAG 5 Plastic screw (塑料铆钉)

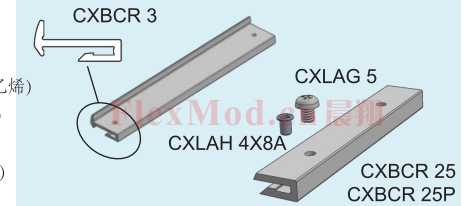

Connecting strip with set screws  
 (梁体连接条)

CXSCJ 6X160 H=20 mm  
 Length 160 mm

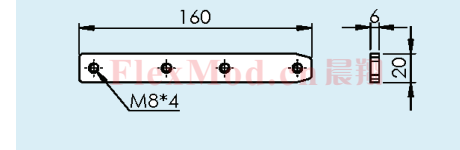

T-slot cover (防尘胶条)

CXCAC 2 Aluminium  
 Length 2 mt (长度2m)

CXCAC 3P Polyvinyl chloride  
 Length 3 mt (长度3m)

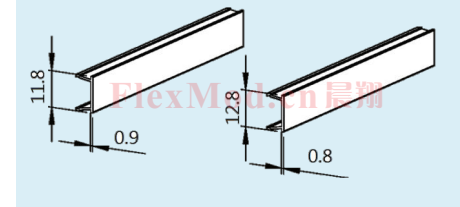

CX3920500 Drill fixture for slide rail (耐磨条安装工具)

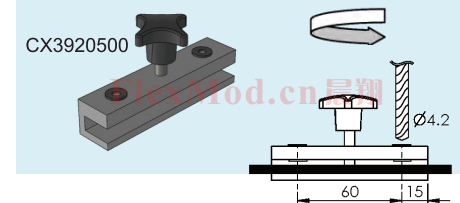

www.flexmod.cn

CXB-295-5

CXB-295

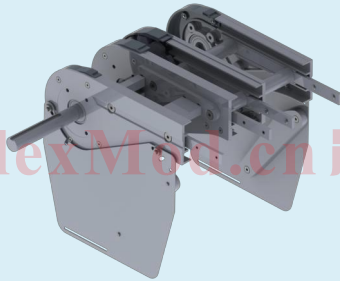

FlexMod.cn 晨翔

CXBEB 0A295LU Basic drive unit  
(基本驱动单元)  
Transmission on  
left-hand side  
(传动装置在左侧)

Dia. 25mm

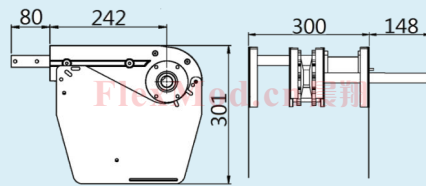

CXBEB 0A295RU Basic drive unit  
(基本驱动单元)  
Transmission on  
right-hand side  
(传动装置在右侧)

Dia. 25mm

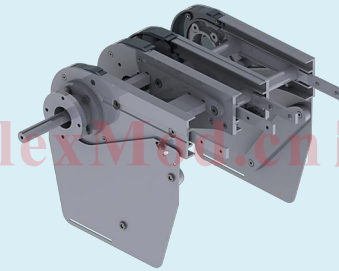
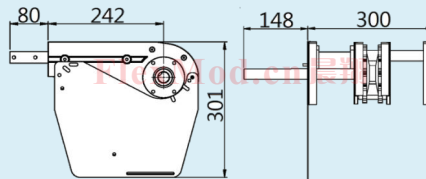

FlexMod.cn 晨翔

CXBEB 0A295LU Drive unit(驱动单元)  
Transmission on  
left-hand side  
(传动装置在左侧)

Dia. 25mm to 20mm

SEW SA37  
SEW WA 30  
SEW WA 20

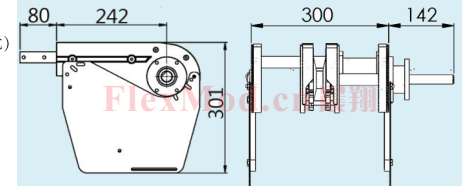

CXBEB 0A295RU Drive unit(驱动单元)  
Transmission on  
left-hand side  
(传动装置在右侧)

Dia. 25mm to 20mm

SEW SA37  
SEW WA 30  
SEW WA 20

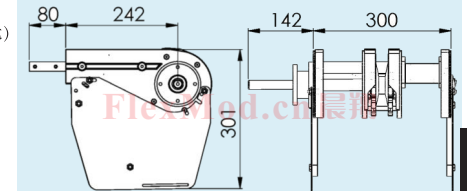

## Idler end units (从动单元)

FlexMod®



CXBEJ 295

Idler end unit (从动单元)

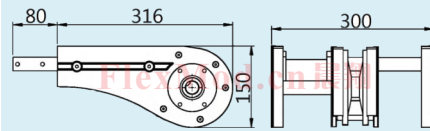

CXB-295-8

## Horizontal plain bends (水平弯头)

FlexMod®

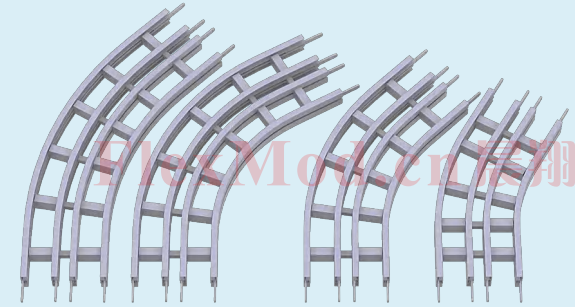

www.flexmod.cn

CXB-295-9

CXB-295

## Horizontal plain bends (水平弯头)

FlexMod®

Horizontal plain bend, 30° (水平弯头30°)  
Radius to centre of beam:  
(输送梁中心半径)

CXBBP 30A295R700 R=700 mm  
CXBBP 30A295R1000 R=1000mm

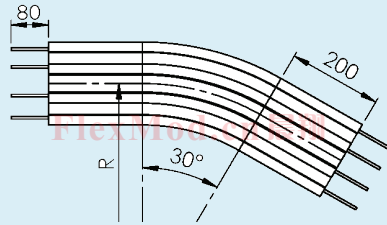

Horizontal plain bend, 45° (水平弯头45°)  
Radius to centre of beam:  
(输送梁中心半径)

CXBBP 45A295R700 R=700 mm  
CXBBP 45A295R1000 R=1000mm

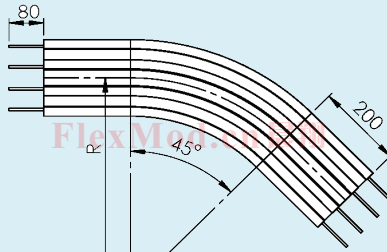

Horizontal plain bend, 60° (水平弯头60°)  
Radius to centre of beam:  
(输送梁中心半径)

CXBBP 60A295R700 R=700 mm  
CXBBP 60A295R1000 R=1000mm

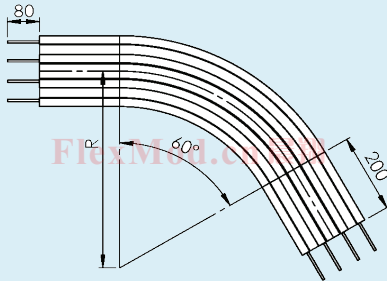

Horizontal plain bend, 90° (水平弯头90°)  
Radius to centre of beam:  
(输送梁中心半径)

CXBBP 90A295R700 R=700 mm  
CXBBP 90A295R1000 R=1000mm

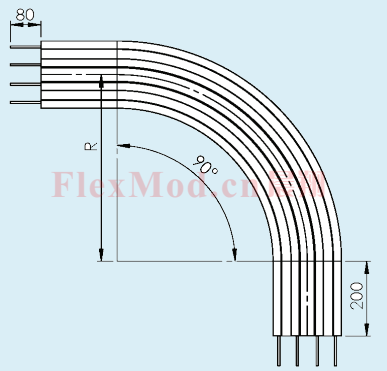

\* Note: Special angles on request.

CXB-295-10

## Vertical bends (垂直弯头)

FlexMod®



CXB-295

www.flexmod.cn

CXB-295-11



## Vertical bends (垂直弯头)

FlexMod®

Vertical bend, 5° (垂直弯头5°)

Radius to centre of beam:  
(输送梁中心半径)

CXBBV 5A295 R750 R=750 mm

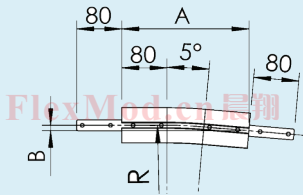

	R	A	B
CXBBV 5A295 R750	750	225	10

Vertical bend, 7° (垂直弯头7°)

Radius to centre of beam:  
(输送梁中心半径)

CXBBV 7A295 R750 R=750 mm

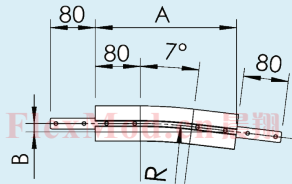

	R	A	B
CXBBV 7A 295 R750	750	251	15

Vertical bend, 15° (垂直弯头15°)

Radius to centre of beam:  
(输送梁中心半径)

CXBBV 15A295 R750 R=750 mm

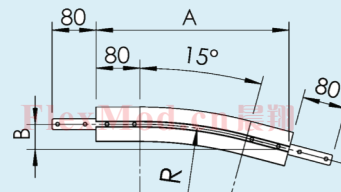

	R	A	B
CXBBV 15A 295 R750	750	351	46

Vertical bend, 30° (垂直弯头30°)

Radius to centre of beam:  
(输送梁中心半径)

CXBBV 30A295 R750 R=750 mm

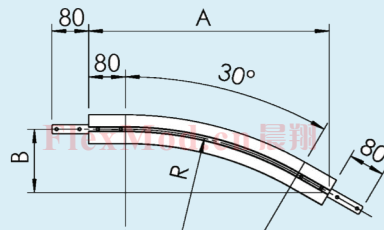

	R	A	B
CXBBV 30A 295 R750	750	524	141

\* Note: Special angles on request.

CXB-295-12

## Vertical bends (垂直弯头)

FlexMod®

Vertical bend, 45° (垂直弯头45°)

Radius to centre of beam:  
(输送梁中心半径)

CXBBV 45A295 R750 R=750 mm

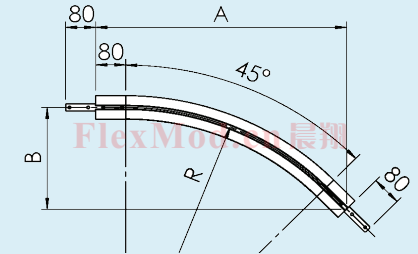

	R	A	B
CXBBV 45A 295 R750	750	667	277

Vertical bend, 60° (垂直弯头60°)

Radius to centre of beam:  
(输送梁中心半径)

CXBBV 60A295 R750 R=750 mm

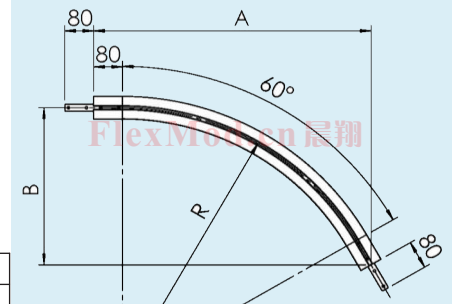

	R	A	B
CXBBV 60A 295 R750	750	770	444

Vertical bend, 90° (垂直弯头90°)

Radius to centre of beam:  
(输送梁中心半径)

CXBBV 90A295 R750 R=750 mm

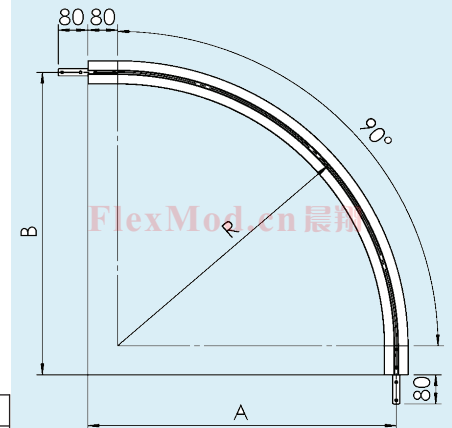

	R	A	B
CXBBV 90A 295 R750	750	830	830

CXB-295

www.flexmod.cn

CXB-295-13